

JARVIN CABINETS

DS-DOVE WHITE SHAKER

SM-SMOKY GRAY

NT-NEWPORT

CS-CREAM WHITE SHAKER

ES-EBONY SHAKER

AB-ARIA BLUE

AL-AVALON

SS-SANDY MIRAGE SHAKER

SO-SODA

CT-CHARLTON

WS-WESTON SHAKER



GS-SAGE GREEN SHAKER

SG-STERLING

PE-PERLA

TS-TOFFEE SHAKER

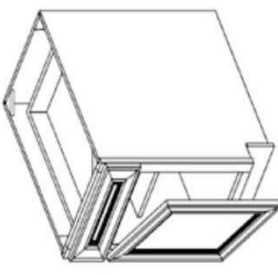
US-UNFINISHED BIRCH SHAKER

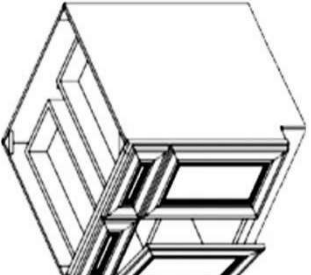
CABINET SPECIFICATION		WEIGHT	DIMENSION		AVAILABILITY														
SKU	LB	W" x H" x D"	DS	ES	SO	SG	SM	AB	CT	PE	NT	AL	TS	WS	CS	SS	GS	US	
BASE CABINET - 1 DRAWER, 1 SHELF																			
	B09	40	9 x 34 1/2 x 24	•	•	•	•	•	•	•	•	•	•	•	•	•	•	•	•
	B12	44	12 x 34 1/2 x 24	•	•	•	•	•	•	•	•	•	•	•	•	•	•	•	•
	B15	48	15 x 34 1/2 x 24	•	•	•	•	•	•	•	•	•	•	•	•	•	•	•	•
	B18	52	18 x 34 1/2 x 24	•	•	•	•	•	•	•	•	•	•	•	•	•	•	•	•
	B21	55	21 x 34 1/2 x 24	•	•	•	•	•	•	•	•	•	•	•	•	•	•	•	•
BASE CABINET - 1 DRAWER, 2 DOOR, 1 SHELF																			
	B24	61	24 x 34 1/2 x 24	•	•	•	•	•	•	•	•	•	•	•	•	•	•	•	•
	B27	67	27 x 34 1/2 x 24	•	•	•	•	•	•	•	•	•	•	•	•	•	•	•	•
	B30	71	30 x 34 1/2 x 24	•	•	•	•	•	•	•	•	•	•	•	•	•	•	•	•
BASE CABINET - 2 DRAWER, 2 DOOR, 1 SHELF																			
	B33	84	33 x 34 1/2 x 24	•	•	•	•	•	•	•	•	•	•	•	•	•	•	•	•
	B36	88	36 x 34 1/2 x 24	•	•	•	•	•	•	•	•	•	•	•	•	•	•	•	•
	B42	89	42 x 34 1/2 x 24	•	•	•	•	•	•	•	•	•	•	•	•	•	•	•	•

JARVIN CABINETS

DS-DOVE WHITE SHAKER
 ES-EBONY SHAKER
 SO-SODA
 SG-STERLING

SM-SMOKY GRAY
 AB-ARIA BLUE
 CT-CHARLTON
 PE-PERLA

NT-NEWPORT
 AL-AVALON
 WS-WESTON SHAKER
 TS-TOFFEE SHAKER

CS-CREAM WHITE SHAKER
 SS-SANDY MIRAGE SHAKER
 GS-SAGE GREEN SHAKER
 US-UNFINISHED BIRCH SHAKER

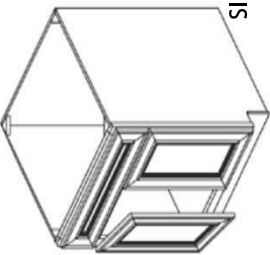
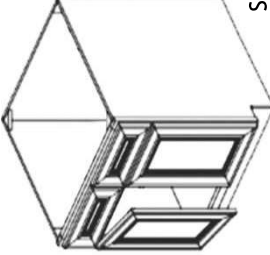
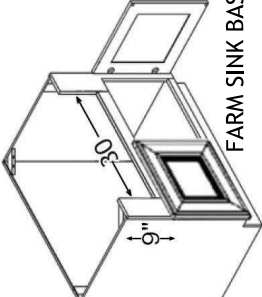
CABINET SPECIFICATION		WEIGHT	DIMENSION		AVAILABILITY														
SKU	LB	W" x H" x D"	DS	ES	SO	SG	SM	AB	CT	PE	NT	AL	TS	WS	CS	SS	GS	US	
SINK BASE CABINET - DUMMY DRAWER FACE, 2 DOORS																			
 <p>SINK BASE</p>	SB24	43	24 x 34 1/2 x 24	●	●	●	●	●	●	●	●	●	●	●	●	●	●	●	●
	SB27	46	27 x 34 1/2 x 24	●	●	●	●	●	●	●	●	●	●	●	●	●	●	●	●
	SB30	50	30 x 34 1/2 x 24	●	●	●	●	●	●	●	●	●	●	●	●	●	●	●	●
SINK BASE CABINET - 2 DUMMY DRAWER FACES, 2 DOORS																			
 <p>SINK BASE</p>	SB33	53	33 x 34 1/2 x 24	●	●	●	●	●	●	●	●	●	●	●	●	●	●	●	●
	SB36	55	36 x 34 1/2 x 24	●	●	●	●	●	●	●	●	●	●	●	●	●	●	●	●
	SB42	62	42 x 34 1/2 x 24	●	●	●	●	●	●	●	●	●	●	●	●	●	●	●	●
33" OR LARGER COMES WITH 2 DUMMY DRAWER FACES																			
FARM SINK BASE CABINET - 2 DOORS																			
 <p>FARM SINK BASE</p>	SB36-S	55	36 x 34 1/2 x 24	●	●	●	●	●	●	●	●	●	●	●	●	●	●	●	●

SB36-S - FARM SINK BASE-OPENING CAN BE CUT TO FIT 33 & 36



JARWIN CABINETS

DS-DOVE WHITE SHAKER
ES-EBONY SHAKER
SO-SODA
SG-STERLING

SM-SMOKY GRAY
AB-ARIA BLUE
CT-CHARLTON
PE-PERLA

NT-NEWPORT
AL-AVALON
WS-WESTON SHAKER
TS-TOFFEE SHAKER

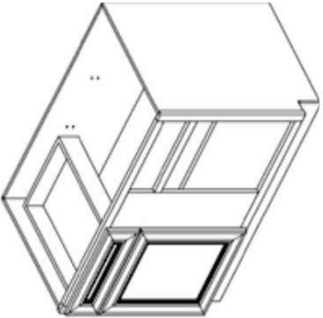
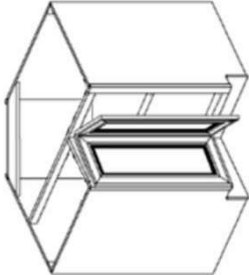
CS-CREAM WHITE SHAKER
SS-SANDY MIRAGE SHAKER
GS-SAGE GREEN SHAKER
US-UNFINISHED BIRCH SHAKER

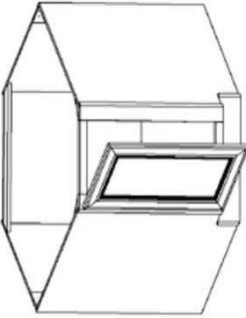
CABINET SPECIFICATION		WEIGHT	DIMENSION		AVAILABILITY														
SKU	LB	W" x H" x D"	DS	ES	SO	SG	SM	AB	CT	PE	NT	AL	TS	WS	CS	SS	GS	US	
BASE BLIND CORNER CABINET - 1 DRAWER, 1 DOOR & 1 SHELF																			
	BBC39	75	39 x 34 1/2 x 24	●	●	●	●	●	●	●	●	●	●	●	●	●	●	●	●
	BBC42	78	42 x 34 1/2 x 24	●	●	●	●	●	●	●	●	●	●	●	●	●	●	●	●
BB39 WITH 15" WIDE DOOR & DRAWER, BBC42 WITH 18" WIDE DOOR & DRAWER																			
*** PULL 3" OUT FROM WALL FOR CLEARANCE - RECOMMENDED ***																			
***** DOOR AND DRAWER ARE REVERSIBLE*****																			
LAZY SUSAN CABINET - FOLDING DOORS - NO TRAY - COMES WITH 1 SHELF																			
	BLS33N*	68	33 x 34 1/2 x 24	●	●	●	●	●	●	●	●	●	●	●	●	●	●	●	●
	BLS36N	76	36 x 34 1/2 x 24	●	●	●	●	●	●	●	●	●	●	●	●	●	●	●	●
	*BLS33N doors are not large enough to accommodate a raised panel. The panels on this door will be recessed (see photo).																		
CORNER SINK CABINET - 1 DOOR 15" WIDE, 1 SHELF																			
	CSB36	77	36 x 34 1/2 x 24	●	●	●	●	●	●	●	●	●	●	●	●	●	●	●	●

JARVIN CABINETS

DS-DOVE WHITE SHAKER

ES-EBONY SHAKER

SO-SODA

SG-STERLING

SM-SMOKY GRAY

AB-ARIA BLUE

CT-CHARLTON

PE-PERLA

NT-NEWPORT

AL-AVALON

WS-WESTON SHAKER

TS-TOFFEE SHAKER

CS-CREAM WHITE SHAKER

SS-SANDY MIRAGE SHAKER

GS-SAGE GREEN SHAKER

US-UNFINISHED BIRCH SHAKER

CABINET SPECIFICATION		WEIGHT	DIMENSION		AVAILABILITY														
SKU	LB	W" x H" x D"	DS	ES	SO	SG	SM	AB	CT	PE	NT	AL	TS	WS	CS	SS	GS	US	
BASE FOR BUILT-IN MICROWAVE CABINET																			
	BMC27	61	27 x 34 1/2 x 24	•	•	•	•	•	•	•	•	•	•	•	•	•	•	•	•
SPICE PULL OUT - 1 FULL HEIGHT DOOR																			
	BSR06	40	6 x 34 1/2 x 24	•	•	•	•	•	•	•	•	•	•	•	•	•	•	•	•
	BSR09	50	9 x 34 1/2 x 24	•	•	•	•	•	•	•	•	•	•	•	•	•	•	•	•
	BSR12	53	12 x 34 1/2 x 24	•	•	•	•	•	•	•	•	•	•	•	•	•	•	•	•
<p>*BSR06 doors are not large enough to accommodate a raised panel. The panels on this door will be recessed (see photo).</p>																			
BASE END CABINET - 18 3/8" DOORS																			
	BEC24	49	24 x 34 1/2 x 24	•	•	•	•	•	•	•	•	•	•	•	•	•	•	•	•

JARVIN CABINETS

DS-DOVE WHITE SHAKER

ES-EBONY SHAKER

SO-SODA

SG-STERLING

SM-SMOKY GRAY

AB-ARIA BLUE

CT-CHARLTON

PE-PERLA

NT-NEWPORT

AL-AVALON

WS-WESTON SHAKER

TS-TOFFEE SHAKER

CS-CREAM WHITE SHAKER

SS-SANDY MIRAGE SHAKER

GS-SAGE GREEN SHAKER

US-UNFINISHED BIRCH SHAKER

CABINET SPECIFICATION

WEIGHT

DIMENSION

AVAILABILITY

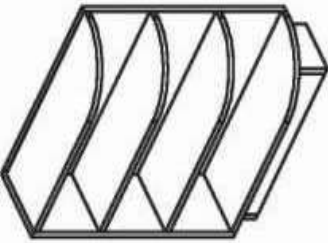
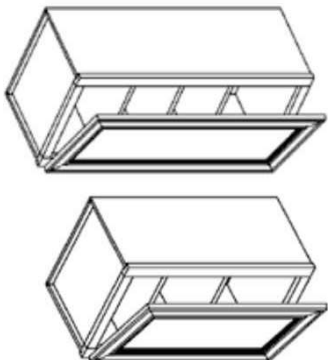
SKU	LB	W" x H" x D"	DS	ES	SO	SG	SM	AB	CT	PE	NT	AL	TS	WS	CS	SS	GS	US	
BES09	33	9 x 34 1/2 x 24	●	●	●	●	●	●	●	●	●	●	●	●	●	●	●	●	●
																			
WALL CABINET - 1 DOOR, 30" - 36" WITH 2 SHELVES, 42" HIGH WITH 3 SHELVES																			
W0930	21	9 x 30 x 12	●	●	●	●	●	●	●	●	●	●	●	●	●	●	●	●	●
W1230	23	12 x 30 x 12	●	●	●	●	●	●	●	●	●	●	●	●	●	●	●	●	●
W1530	27	15 x 30 x 12	●	●	●	●	●	●	●	●	●	●	●	●	●	●	●	●	●
W1830	30	18 x 30 x 12	●	●	●	●	●	●	●	●	●	●	●	●	●	●	●	●	●
W2130	34	21 x 30 x 12	●	●	●	●	●	●	●	●	●	●	●	●	●	●	●	●	●
W0936	23	9 x 36 x 12	●	●	●	●	●	●	●	●	●	●	●	●	●	●	●	●	●
W1236	27	12 x 36 x 12	●	●	●	●	●	●	●	●	●	●	●	●	●	●	●	●	●
W1536	31	15 x 36 x 12	●	●	●	●	●	●	●	●	●	●	●	●	●	●	●	●	●
W1836	35	18 x 36 x 12	●	●	●	●	●	●	●	●	●	●	●	●	●	●	●	●	●
W2136	38	21 x 36 x 12	●	●	●	●	●	●	●	●	●	●	●	●	●	●	●	●	●
W0942	28	9 x 42 x 12	●	●	●	●	●	●	●	●	●	●	●	●	●	●	●	●	●
W1242	31	12 x 42 x 12	●	●	●	●	●	●	●	●	●	●	●	●	●	●	●	●	●
W1542	36	15 x 42 x 12	●	●	●	●	●	●	●	●	●	●	●	●	●	●	●	●	●
W1842	40	18 x 42 x 12	●	●	●	●	●	●	●	●	●	●	●	●	●	●	●	●	●
W2142	46	21 x 42 x 12	●	●	●	●	●	●	●	●	●	●	●	●	●	●	●	●	●
																			

JARVIN CABINETS

DS-DOVE WHITE SHAKER

ES-EBONY SHAKER

SO-SODA

SG-STERLING

SM-SMOKY GRAY

AB-ARIA BLUE

CT-CHARLTON

PE-PERLA

NT-NEWPORT

AL-AVALON

WS-WESTON SHAKER

TS-TOFFEE SHAKER

CS-CREAM WHITE SHAKER

SS-SANDY MIRAGE SHAKER

GS-SAGE GREEN SHAKER

US-UNFINISHED BIRCH SHAKER

CABINET SPECIFICATION

WEIGHT DIMENSION

AVAILABILITY

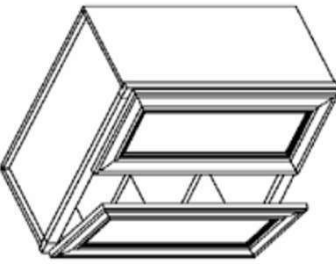
SKU	LB	W" x H" x D"	DS	ES	SO	SG	SM	AB	CT	PE	NT	AL	TS	WS	CS	SS	GS	US
WALL CABINETS - 2 DOOR, 2 SHELVES																		
	W2430	37	24 x 30 x 12	●	●	●	●	●	●	●	●	●	●	●	●	●	●	●
	W2730	42	27 x 30 x 12	●	●	●	●	●	●	●	●	●	●	●	●	●	●	●
	W3030	46	30 x 30 x 12	●	●	●	●	●	●	●	●	●	●	●	●	●	●	●
	W3330	47	33 x 30 x 12	●	●	●	●	●	●	●	●	●	●	●	●	●	●	●
	W3630	53	36 x 30 x 12	●	●	●	●	●	●	●	●	●	●	●	●	●	●	●
	W2436	43	24 x 36 x 12	●	●	●	●	●	●	●	●	●	●	●	●	●	●	●
	W2736	47	27 x 36 x 12	●	●	●	●	●	●	●	●	●	●	●	●	●	●	●
	W3036	53	30 x 36 x 12	●	●	●	●	●	●	●	●	●	●	●	●	●	●	●
	W3336	57	33 x 36 x 12	●	●	●	●	●	●	●	●	●	●	●	●	●	●	●
	W3636	60	36 x 36 x 12	●	●	●	●	●	●	●	●	●	●	●	●	●	●	●

WALL CABINETS - 2 DOOR, 3 SHELVES

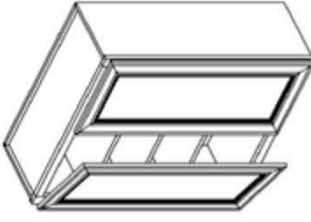
	W2442	50	24 x 42 x 12	●	●	●	●	●	●	●	●	●	●	●	●	●	●	●
	W2742	55	27 x 42 x 12	●	●	●	●	●	●	●	●	●	●	●	●	●	●	●
	W3042	62	30 x 42 x 12	●	●	●	●	●	●	●	●	●	●	●	●	●	●	●
	W3342	66	33 x 42 x 12	●	●	●	●	●	●	●	●	●	●	●	●	●	●	●
	W3642	73	36 x 42 x 12	●	●	●	●	●	●	●	●	●	●	●	●	●	●	●

WALL DIAGONAL CORNER STACKER CABINET

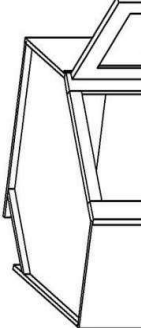
	WDC2412	27	24 x 12 x 12	●														●
	WDC2418	29	24 x 18 x 12	●	●													●

Use 15" glass doors with above. For 12" tall WDC2412 use WM1512, for 18" tall WDC2418 use WM1518

JARVIN CABINETS

DS-DOVE WHITE SHAKER
ES-EBONY SHAKER
SO-SODA
SG-STERLING

SM-SMOKY GRAY
AB-ARIA BLUE
CT-CHARLTON
PE-PERLA

NT-NEWPORT
AL-AVALON
WS-WESTON SHAKER
TS-TOFFEE SHAKER

CS-CREAM WHITE SHAKER
SS-SANDY MIRAGE SHAKER
GS-SAGE GREEN SHAKER
US-UNFINISHED BIRCH SHAKER

CABINET SPECIFICATION		WEIGHT	DIMENSION		AVAILABILITY														
SKU	LB	W" x H" x D"	DS	ES	SO	SG	SM	AB	CT	PE	NT	AL	TS	WS	CS	SS	GS	US	
EASY REACH CORNER WALL CABINET - FOLDING DOORS																			
WLS2442	70	24 x 42 x 12	●	●	●	●	●	●	●	●	●	●	●	●	●	●	●	●	●
WALL END CABINET 2 DOOR, 30" - 36" WITH 2 SHELVES, 42" HIGH WITH 3 SHELVES																			
WEC1230	23	12 x 30 x 12	●	●	●	●	●	●	●	●	●	●	●	●	●	●	●	●	●
WEC1236	27	12 x 36 x 12	●	●	●	●	●	●	●	●	●	●	●	●	●	●	●	●	●
WEC1242	33	12 x 42 x 12	●	●	●	●	●	●	●	●	●	●	●	●	●	●	●	●	●
WALL BRIDGE (STACKER) CABINETS - 1 DOOR																			
W1212	7	12 x 12 x 12	●																●
W1512	9	15 x 12 x 12	●																●
W1812	11	18 x 12 x 12	●																●
W2112	13	21 x 12 x 12	●																●
W1218	8	12 x 18 x 12	●				●												●
W1518	10	15 x 18 x 12	●				●												●
W1818	12	18 x 18 x 12	●				●												●
W2118	14	21 x 18 x 12	●				●												●

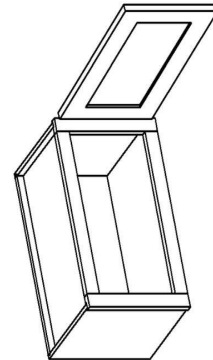
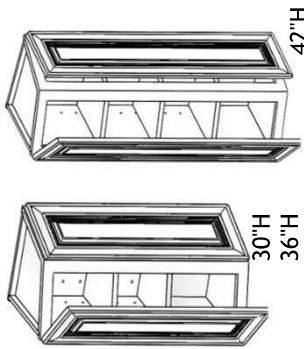

GLASS DOORS ARE AVAILABLE. USE MATCHING "WM" SKU-
E.G.: W1212 USES WM1212, W1218 USES WM1218, ETC.

JARWIN CABINETS

DS-DOVE WHITE SHAKER

SM-SMOKY GRAY

NT-NEWPORT

CS-CREAM WHITE SHAKER

ES-EBONY SHAKER

AB-ARIA BLUE

AL-AVALON

SS-SANDY MIRAGE SHAKER

SO-SODA

CT-CHARLTON

WS-WESTON SHAKER

GS-SAGE GREEN SHAKER

SG-STERLING

PE-PERLA

TS-TOFFEE SHAKER

US-UNFINISHED BIRCH SHAKER

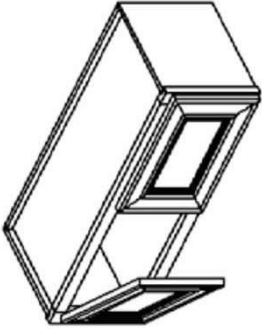
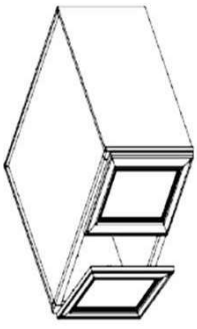
CABINET SPECIFICATION		WEIGHT	DIMENSION		AVAILABILITY														
SKU	LB	W" x H" x D"	DS	ES	SO	SG	SM	AB	CT	PE	NT	AL	TS	WS	CS	SS	GS	US	
WALL BRIDGE (STACKER) CABINETS - 2 DOOR																			
		14	24 x 12 x 12	•	•	•	•	•	•	•	•	•	•	•	•	•	•	•	•
W2412		14	24 x 12 x 12	•	•	•	•	•	•	•	•	•	•	•	•	•	•	•	•
W2712		18	27 x 12 x 12	•															
W3012		21	30 x 12 x 12	•	•	•	•	•	•	•	•	•	•	•	•	•	•	•	•
W3312		23	33 x 12 x 12	•	•	•	•	•	•	•	•	•	•	•	•	•	•	•	•
W3612		25	36 x 12 x 12	•	•	•	•	•	•	•	•	•	•	•	•	•	•	•	•
W3015		24	30 x 15 x 12	•	•	•	•	•	•	•	•	•	•	•	•	•	•	•	•
W3315		27	33 x 15 x 12	•	•	•	•	•	•	•	•	•	•	•	•	•	•	•	•
W3615		27	36 x 15 x 12	•	•	•	•	•	•	•	•	•	•	•	•	•	•	•	•
W2418		16	24 x 18 x 12	•															
W2718		20	27 x 18 x 12	•															
W3018		27	30 x 18 x 12	•	•	•	•	•	•	•	•	•	•	•	•	•	•	•	•
W3318		30	33 x 18 x 12	•	•	•	•	•	•	•	•	•	•	•	•	•	•	•	•
W3618		31	36 x 18 x 12	•	•	•	•	•	•	•	•	•	•	•	•	•	•	•	•
W3024		36	30 x 24 x 12	•	•	•	•	•	•	•	•	•	•	•	•	•	•	•	•
W3324		40	33 x 24 x 12	•	•	•	•	•	•	•	•	•	•	•	•	•	•	•	•
W3624		42	36 x 24 x 12	•	•	•	•	•	•	•	•	•	•	•	•	•	•	•	•
WALL BRIDGE (STACKER) CABINETS - 2 DOOR																			
		32	30 x 12 x 24	•	•	•	•	•	•	•	•	•	•	•	•	•	•	•	•
W301224		32	30 x 12 x 24	•	•	•	•	•	•	•	•	•	•	•	•	•	•	•	•
W301824		37	30 x 18 x 24	•	•	•	•	•	•	•	•	•	•	•	•	•	•	•	•
W31.51224		36	31.5 x 12 x 24	•															
W31.51824		38	31.5 x 18 x 24	•															
W361224		35	36 x 12 x 24	•	•	•	•	•	•	•	•	•	•	•	•	•	•	•	•
W361524		40	36 x 15 x 24	•	•	•	•	•	•	•	•	•	•	•	•	•	•	•	•
W361824		51	36 x 18 x 24	•	•	•	•	•	•	•	•	•	•	•	•	•	•	•	•

JARVIN CABINETS

DS-DOVE WHITE SHAKER

ES-EBONY SHAKER

SO-SODA

SG-STERLING

SM-SMOKY GRAY

AB-ARIA BLUE

CT-CHARLTON

PE-PERLA

NT-NEWPORT

AL-AVALON

WS-WESTON SHAKER

TS-TOFFEE SHAKER

CS-CREAM WHITE SHAKER

SS-SANDY MIRAGE SHAKER

GS-SAGE GREEN SHAKER

US-UNFINISHED BIRCH SHAKER

CABINET SPECIFICATION

AVAILABILITY

WEIGHT DIMENSION

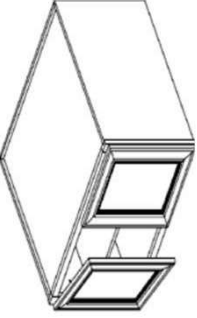
SKU	LB	W" x H" x D"	DS	ES	SO	SG	SM	AB	CT	PE	NT	AL	TS	WS	CS	SS	GS	US
WALL BRIDGE CABINETS - 2 DOOR, 1 SHELF																		
	W302424	53	30 x 24 x 24	●	●	●	●	●	●	●	●	●	●	●	●	●	●	●
	W362424	60	36 x 24 x 24	●	●	●	●	●	●	●	●	●	●	●	●	●	●	●

SINGLE DOOR TALL PANTRY - 6 SHELVES ON 84" - 90", 7 SHELVES ON 96"

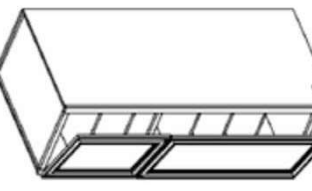
	WP1884	114	18 x 84 x 24	●	●	●	●	●	●	●	●	●	●	●	●	●	●	●
	WP1890	117	18 x 90 x 24	●	●	●	●	●	●	●	●	●	●	●	●	●	●	●
	WP1896	125	18 x 96 x 24	●	●	●	●	●	●	●	●	●	●	●	●	●	●	●

BOTTOM DOOR 49-1/4", TOP DOOR 30", 36", 42" MATCH STANDARD WALL CABINETS

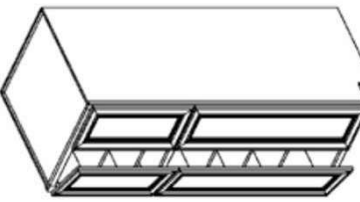

DOUBLE DOOR TALL PANTRY - 6 SHELVES ON 84" - 90", 7 SHELVES ON 96"

	WP2484	135	24 x 84 x 24	●	●	●	●	●	●	●	●	●	●	●	●	●	●	●
	WP2490	142	24 x 90 x 24	●	●	●	●	●	●	●	●	●	●	●	●	●	●	●
	WP2496	167	24 x 96 x 24	●	●	●	●	●	●	●	●	●	●	●	●	●	●	●
	WP3084	165	30 x 84 x 24	●	●	●	●	●	●	●	●	●	●	●	●	●	●	●
	WP3090	169	30 x 90 x 24	●	●	●	●	●	●	●	●	●	●	●	●	●	●	●
	WP3096	195	30 x 96 x 24	●	●	●	●	●	●	●	●	●	●	●	●	●	●	●

BOTTOM DOOR 49-1/4", TOP DOOR 30", 36", 42" MATCH STANDARD WALL CABINETS

JARVIN CABINETS

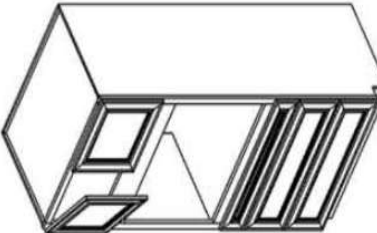
- DS-DOVE WHITE SHAKER
- ES-EBONY SHAKER
- SO-SODA
- SG-STERLING
- SM-SMOKY GRAY
- AB-ARIA BLUE
- CT-CHARLTON
- PE-PERLA
- NT-NEWPORT
- AL-AVALON
- WS-WESTON SHAKER
- TS-TOFFEE SHAKER
- CS-CREAM WHITE SHAKER
- SS-SANDY MIRAGE SHAKER
- GS-SAGE GREEN SHAKER
- US-UNFINISHED BIRCH SHAKER

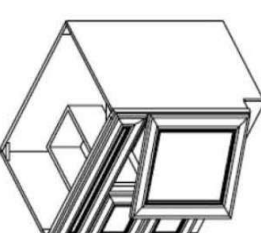
CABINET SPECIFICATION		WEIGHT	DIMENSION		AVAILABILITY														
SKU	LB	W" x H" x D"	DS	ES	SO	SG	SM	AB	CT	PE	NT	AL	TS	WS	CS	SS	GS	US	
OVEN PANTRY - 3 DRAWER, 2 DOOR																			
	OC31.584	190	31 1/2 x 84 x 24	•	•	•	•	•	•	•	•	•	•	•	•	•	•	•	•
	OC31.590	199	31 1/2 x 90 x 24	•	•	•	•	•	•	•	•	•	•	•	•	•	•	•	•
	OC31.596	202	31 1/2 x 96 x 24	•	•	•	•	•	•	•	•	•	•	•	•	•	•	•	•
THESE PANTRIES CAN BE USED EITHER SINGLE OVEN OR DOUBLE OVEN LEAVE TWO TOP DRAWERS OUT FOR DOUBLE OVEN																			
VANITIES SINK BASE - 1 DUMMY DRAWER FACE, 2 DOOR																			
	FA2421	39	24 x 34 1/2 x 21	•	•	•	•	•	•	•	•	•	•	•	•	•	•	•	•
	FA2721	47	27 x 34 1/2 x 21											•					
	FA3021	47	30 x 34 1/2 x 21	•	•	•	•	•	•	•	•	•	•	•	•	•	•	•	•
	FA3621	47	36 x 34 1/2 x 21											•					
VANITIES SINK BASE - 2 DRAWER, 1 DUMMY DRAWER FACE																			
	FA3021DR	75	30 x 34 1/2 x 21	•	•	•	•	•	•	•	•	•	•	•	•	•	•	•	•



JARVIN CABINETS

DS-DOVE WHITE SHAKER
 ES-EBONY SHAKER
 SO-SODA
 SG-STERLING

SM-SMOKY GRAY
 AB-ARIA BLUE
 CT-CHARLTON
 PE-PERLA

NT-NEWPORT
 AL-AVALON
 WS-WESTON SHAKER
 TS-TOFFEE SHAKER

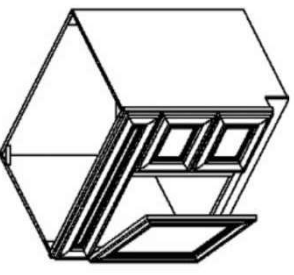
CS-CREAM WHITE SHAKER
 SS-SANDY MIRAGE SHAKER
 GS-SAGE GREEN SHAKER
 US-UNFINISHED BIRCH SHAKER

CABINET SPECIFICATION		WEIGHT	DIMENSION	AVAILABILITY															
SKU	LB	W" x H" x D"	DS	ES	SO	SG	SM	AB	CT	PE	NT	AL	TS	WS	CS	SS	GS	US	
VANITIES SINK BASE - 2 DRAWER, 1 DUMMY DRAWER FACE																			
	FA3021DL	75	30 x 34 1/2 x 21	●	●	●	●	●	●	●	●	●	●	●	●	●	●	●	●
VANITIES SINK BASE - 2 DOOR, 2 DRAWER, 1 DUMMY DRAWER FACE																			
	FA3621DL	83	36 x 34 1/2 x 21	●	●	●	●	●	●	●	●	●	●	●	●	●	●	●	●
	FA4221DL	94	42 x 34 1/2 x 21	●	●	●	●	●	●	●	●	●	●	●	●	●	●	●	●
VANITIES SINK BASE - 2 DOOR, 2 DRAWER, 1 DUMMY DRAWER FACE																			
	FA3621DR	83	36 x 34 1/2 x 21	●	●	●	●	●	●	●	●	●	●	●	●	●	●	●	●
	FA4221DR	94	42 x 34 1/2 x 21	●	●	●	●	●	●	●	●	●	●	●	●	●	●	●	●



JARVIN CABINETS

DS-DOVE WHITE SHAKER
ES-EBONY SHAKER
SO-SODA
SG-STERLING

SM-SMOKY GRAY
AB-ARIA BLUE
CT-CHARLTON
PE-PERLA

NT-NEWPORT
AL-AVALON
WS-WESTON SHAKER
TS-TOFFEE SHAKER

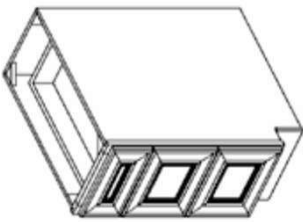
CS-CREAM WHITE SHAKER
SS-SANDY MIRAGE SHAKER
GS-SAGE GREEN SHAKER
US-UNFINISHED BIRCH SHAKER

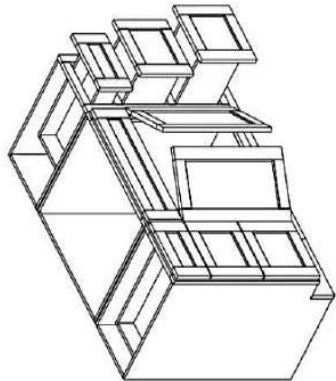
CABINET SPECIFICATION		SKU	LB	DIMENSION		AVAILABILITY																
				W" x H" x D"	DS	ES	SO	SG	SM	AB	CT	PE	NT	AL	TS	WS	CS	SS	GS	US		
 <p>VANITIES DRAWER BASE - 3 DRAWER</p>		SVA12D	61	12 x 34 1/2 x 21	●	●	●	●	●	●	●	●	●	●	●	●	●	●	●	●		
		SVA15D	65	15 x 34 1/2 x 21	●	●	●	●	●	●	●	●	●	●	●	●	●	●	●	●	●	
		SVA18D	72	18 x 34 1/2 x 21	●	●	●	●	●	●	●	●	●	●	●	●	●	●	●	●	●	●
		SVA24D	79	24 x 34 1/2 x 21	●	●	●	●	●	●	●	●	●	●	●	●	●	●	●	●	●	●
 <p>KNEE DRAWER - 1 DRAWER</p>		FD24	24	24 x 7 1/2 x 21	●	●	●	●	●	●	●	●	●	●	●	●	●	●	●	●		
		FD30	30	30 x 7 1/2 x 21	●	●	●	●	●	●	●	●	●	●	●	●	●	●	●	●	●	
 <p>VANITIES SINK BASE - 2 DOOR, 6 DRAWER, 1 DUMMY DRAWER FACE</p>		FA4821	140	48 x 34 1/2 x 21	●																	
		FA6021	154	60 x 34 1/2 x 21	●																	

DRAWER FRONT SIZES FOR FA4821: 12", 24", 12"
FA6021: 15", 30", 15"

JARVIN CABINETS

DS-DOVE WHITE SHAKER
 ES-EBONY SHAKER
 SO-SODA
 SG-STERLING

SM-SMOKY GRAY
 AB-ARIA BLUE
 CT-CHARLTON
 PE-PERLA

NT-NEWPORT
 AL-AVALON
 WS-WESTON SHAKER
 TS-TOFFEE SHAKER

CS-CREAM WHITE SHAKER
 SS-SANDY MIRAGE SHAKER
 GS-SAGE GREEN SHAKER
 US-UNFINISHED BIRCH SHAKER

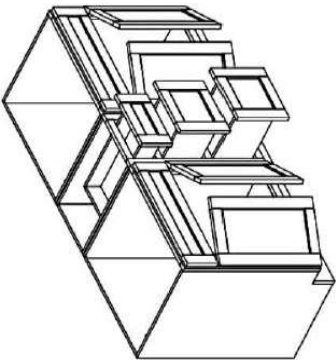
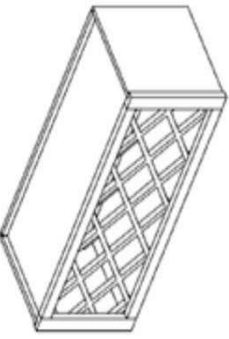
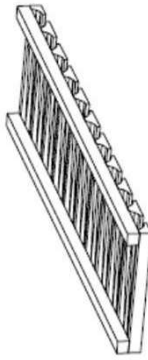
CABINET SPECIFICATION		WEIGHT	DIMENSION		AVAILABILITY														
SKU	LB	W" x H" x D"	DS	ES	SO	SG	SM	AB	CT	PE	NT	AL	TS	WS	CS	SS	GS	US	
VANITIES SINK BASE - 4 DOOR, 3 DRAWER, 2 DUMMY DRAWER FACE																			
FA6021D	117	60 x 34 1/2 x 21	●			●													
																			
WALL WINE RACK																			
WR3015	23	30 x 15 x 12	●	●	●	●	●	●	●	●	●	●	●	●	●	●	●	●	●
WR3615	27	36 x 15 x 12	●	●	●	●	●	●	●	●	●	●	●	●	●	●	●	●	●
																			
WALL GLASS RACK																			
SGH3012	7	30 x 3 x 12	●	●	●	●	●	●	●	●	●	●	●	●	●	●	●	●	●
SGH3612	8	36 x 3 x 12	●	●	●	●	●	●	●	●	●	●	●	●	●	●	●	●	●
																			

JARVIN CABINETS

DS-DOVE WHITE SHAKER

ES-EBONY SHAKER

SO-SODA

SG-STERLING

SM-SMOKY GRAY

AB-ARIA BLUE

CT-CHARLTON

PE-PERLA

NT-NEWPORT

AL-AVALON

WS-WESTON SHAKER

TS-TOFFEE SHAKER

CS-CREAM WHITE SHAKER

SS-SANDY MIRAGE SHAKER

GS-SAGE GREEN SHAKER

US-UNFINISHED BIRCH SHAKER

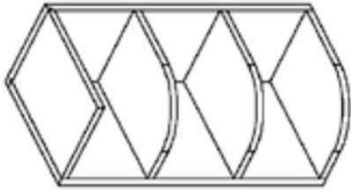
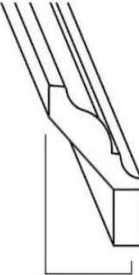
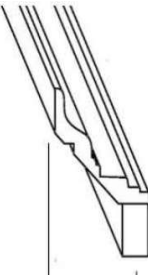
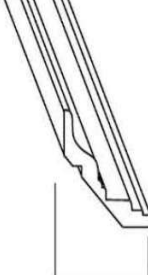
CABINET SPECIFICATION		WEIGHT	DIMENSION		AVAILABILITY															
SKU	LB	W" x H" x D"	DS	ES	SO	SG	SM	AB	CT	PE	NT	AL	TS	WS	CS	SS	GS	US		
WALL END OPEN SHELF																				
	WES0930	18	9 x 30 x 12	•	•	•	•	•	•	•	•	•	•	•	•	•	•	•	•	
	WES0936	24	9 x 36 x 12	•	•	•	•	•	•	•	•	•	•	•	•	•	•	•	•	
	WES0942	23	9 x 42 x 12	•	•	•	•	•	•	•	•	•	•	•	•	•	•	•	•	
3 SHELVES ON 30" & 36" H, 4 SHELVES ON 42"H																				
CROWN MOLDING																				
	ACM8	8	2 1/2 x 96						•	•	•	•								
CLASSIC CROWN MOLDING																				
	CCM8	6	3 1/4 x 96							•	•	•								
CROWN MOLDING																				
	CM8	3	3 1/4 x 96																	

JARVIN CABINETS

DS-DOVE WHITE SHAKER
ES-EBONY SHAKER
SO-SODA
SG-STERLING

SM-SMOKY GRAY
AB-ARIA BLUE
CT-CHARLTON
PE-PERLA

NT-NEWPORT
AL-AVALON
WS-WESTON SHAKER
TS-TOFFEE SHAKER

CS-CREAM WHITE SHAKER
SS-SANDY MIRAGE SHAKER
GS-SAGE GREEN SHAKER
US-UNFINISHED BIRCH SHAKER

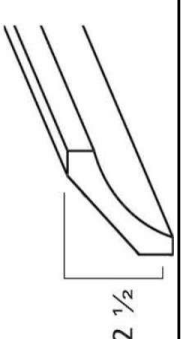
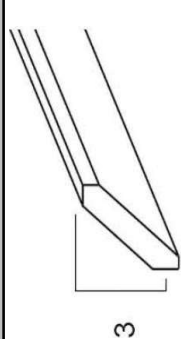
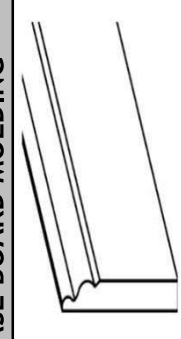
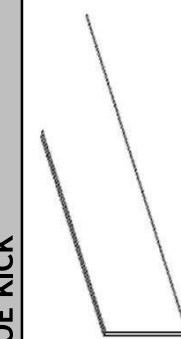
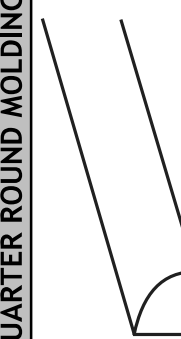
CABINET SPECIFICATION		WEIGHT	DIMENSION		AVAILABILITY														
SKU	LB	W" x H" x D"	DS	ES	SO	SG	SM	AB	CT	PE	NT	AL	TS	WS	CS	SS	GS	US	
SHAKER COVE CROWN MOLDING																			
	3	2 1/2 x 96	•	•	•	•	•	•					•	•	•	•	•	•	•
CM8-C																			
CM8-C2	3	3 1/2 x 96	•																
SHAKER ANGLED CROWN MOLDING																			
	4	3 x 96	•	•	•	•	•	•					•	•	•	•	•	•	•
CM8-S																			
BASE BOARD MOLDING																			
	6	4 1/2 x 3/4 x 96	•	•	•	•	•	•	•	•	•	•	•	•	•	•	•	•	•
BM8																			
TOE KICK																			
	2	4 1/2 x 1/4 x 96	•	•	•	•	•	•	•	•	•	•	•	•	•	•	•	•	•
TK8																			
QUARTER ROUND MOLDING																			
	1	3/4 x 3/4 x 96	•	•	•	•	•	•	•	•	•	•	•	•	•	•	•	•	•
QRM8																			

JARVIN CABINETS

DS-DOVE WHITE SHAKER

ES-EBONY SHAKER

SO-SODA

SG-STERLING

SM-SMOKY GRAY

AB-ARIA BLUE

CT-CHARLTON

PE-PERLA

NT-NEWPORT

AL-AVALON

WS-WESTON SHAKER

TS-TOFFEE SHAKER

CS-CREAM WHITE SHAKER

SS-SANDY MIRAGE SHAKER

GS-SAGE GREEN SHAKER

US-UNFINISHED BIRCH SHAKER

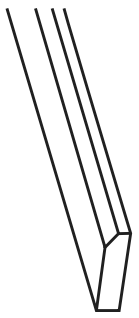
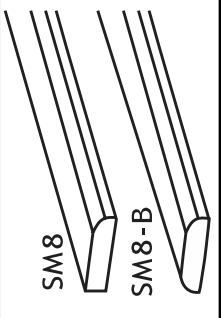
CABINET SPECIFICATION		WEIGHT		DIMENSION			AVAILABILITY													
		SKU	LB	W" x H" x D"	DS	ES	SO	SG	SM	AB	CT	PE	NT	AL	TS	WS	CS	SS	GS	US
	BEM8	3	2 1/4 x 3/4 x 96	•	•	•	•	•	•	•	•	•	•	•	•	•	•	•	•	•
	SM8	0.4	3/4 x 1/4 x 96	•	•	•	•	•	•	•	•	•	•	•	•	•	•	•	•	•
	SM8-B	0.4	3/4 x 1/4 x 96	•	•	•	•	•	•	•	•	•	•	•	•	•	•	•	•	•
	BOTH EDGES ROUNDED ON THIS ONE ONLY																			
	TLR8-1	1	1 1/2 x 2 x 96	•	•	•	•	•	•	•	•	•	•	•	•	•	•	•	•	•
	TLR8-2	1	1 1/2 x 2 x 96	•	•	•	•	•	•	•	•	•	•	•	•	•	•	•	•	•
	OCM8	1	3/4 x 3/4 x 96	•	•	•	•	•	•	•	•	•	•	•	•	•	•	•	•	•
	BOTH EDGES ROUNDED ON THIS ONE ONLY																			

JARVIN CABINETS

DS-DOVE WHITE SHAKER

SM-SMOKY GRAY

NT-NEWPORT

CS-CREAM WHITE SHAKER

ES-EBONY SHAKER

AB-ARIA BLUE

AL-AVALON

SS-SANDY MIRAGE SHAKER

SO-SODA

CT-CHARLTON

WS-WESTON SHAKER



GS-SAGE GREEN SHAKER

SG-STERLING

PE-PERLA

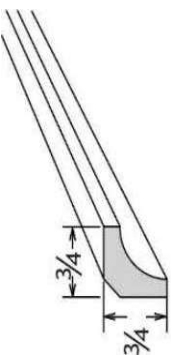
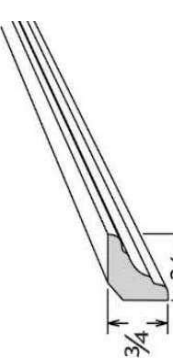

TS-TOFFEE SHAKER

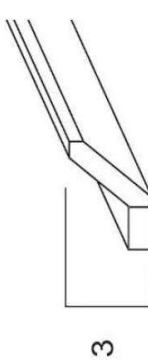
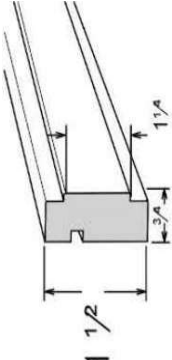
US-UNFINISHED BIRCH SHAKER

CABINET SPECIFICATION		WEIGHT	DIMENSION	AVAILABILITY															
SKU	LB	W" x H" x D"	DS	ES	SO	SG	SM	AB	CT	PE	NT	AL	TS	WS	CS	SS	GS	US	
SHAKER INSIDE CORNER MOLDING																			
	QM8WD	2	3/4 x 3/4 x 96	•	•	•	•	•											
DECORATIVE INSIDE CORNER MOLDING																			
	ICM8	2	3/4 x 3/4 x 96						•	•	•	•							
SHAKER COVE CROWN MOLDING																			
	ACM8-C	8	2 1/2 x 96	•	•	•	•	•					•	•	•	•	•	•	•
SHAKER ANGLE CROWN MOLDING																			
	ACM8-S	8	3 1/4 x 96	•	•	•	•	•					•	•	•	•	•	•	•
SHAKER SQUARE CHAIR RAIL MOLDING																			
	SQCR8	1	1 1/2 x 3/4 x 96	•	•	•	•	•											

JARVIN CABINETS

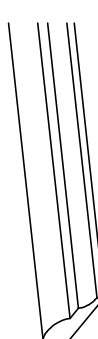
DS-DOVE WHITE SHAKER SM-SMOKY GRAY NT-NEWPORT CS-CREAM WHITE SHAKER
 ES-EBONY SHAKER AB-ARIA BLUE AL-AVALON SS-SANDY MIRAGE SHAKER
 SO-SODA CT-CHARLTON WS-WESTON SHAKER GS-SAGE GREEN SHAKER
 SG-STERLING PE-PERLA TS-TOFFEE SHAKER US-UNFINISHED BIRCH SHAKER

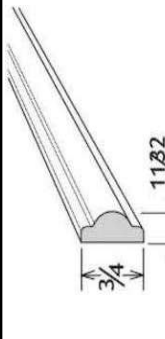
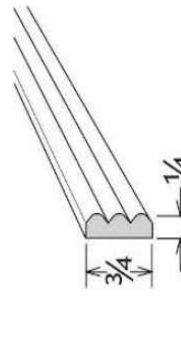
CABINET SPECIFICATION		WEIGHT	DIMENSION		AVAILABILITY														
SKU	LB	W" x H" x D"	DS	ES	SO	SG	SM	AB	CT	PE	NT	AL	TS	WS	CS	SS	GS	US	
CHAIR RAIL MOLDING																			
	CR8	1	1 1/2 x 3/4 x 96						•	•	•	•							
DENTAL MOLDING INSERT																			
	DM18	0.3	3/4 x 1/2 x 96						•	•	•	•							
ROPE MOLDING INSERT																			
	RM18	0.4	3/4 x 1/2 x 96						•	•	•	•							
SINGLE BEAD INSERT MOLDING																			
	SB18	1	3/4 x 11/32 x 96						•	•	•	•							
TRIPLE BEAD INSERT MOLDING																			
	TB18	1	3/4 x 1/4 x 96						•	•	•	•							

OPTION- IT CAN BE APPLIED ON TO CCM8 OR CM8

OPTION- IT CAN BE APPLIED ON TO CCM8 OR CM8

JARVIN CABINETS

DS-DOVE WHITE SHAKER
 ES-EBONY SHAKER
 SO-SODA
 SG-STERLING

SM-SMOKY GRAY
 AB-ARIA BLUE
 CT-CHARLTON
 PE-PERLA

NT-NEWPORT
 AL-AVALON
 WS-WESTON SHAKER
 TS-TOFFEE SHAKER

CS-CREAM WHITE SHAKER
 SS-SANDY MIRAGE SHAKER
 GS-SAGE GREEN SHAKER
 US-UNFINISHED BIRCH SHAKER

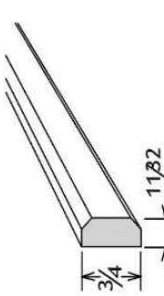
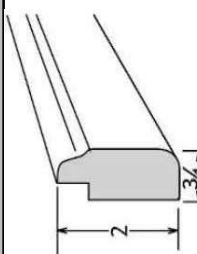
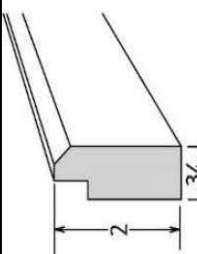
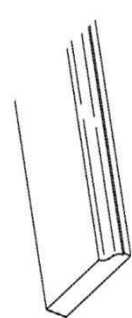
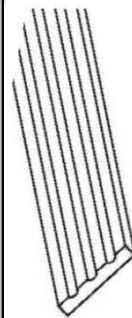
CABINET SPECIFICATION		WEIGHT	DIMENSION		AVAILABILITY																
SKU	LB	W"	H"	x D"	DS	ES	SO	SG	SM	AB	CT	PE	NT	AL	TS	WS	CS	SS	GS	US	
SHAKER INSERT MOLDING																					
	SIM8	1	3/4	x 11/32	x 96	•	•	•	•	•											
MIRROR MOLDING																					
	MM8	2	2	x 3/4	x 96						•	•	•	•							
SHAKER MIRROR MOLDING																					
	SMM8	2	2	x 3/4	x 96	•	•	•	•	•											
OGEE MOLDING																					
	OGM8	3	2	x 3/4	x 96						•	•	•	•							
FLUTED FILLER																					
	PCVFF3	4	3	x 3/4	x 96	•	•	•	•	•	•	•	•	•							



JARVIN CABINETS

DS-DOVE WHITE SHAKER
ES-EBONY SHAKER
SO-SODA
SG-STERLING

SM-SMOKY GRAY
AB-ARIA BLUE
CT-CHARLTON
PE-PERLA

NT-NEWPORT
AL-AVALON
WS-WESTON SHAKER
TS-TOFFEE SHAKER

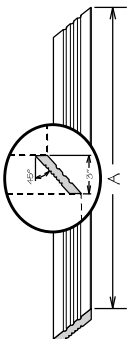
CS-CREAM WHITE SHAKER
SS-SANDY MIRAGE SHAKER
GS-SAGE GREEN SHAKER
US-UNFINISHED BIRCH SHAKER

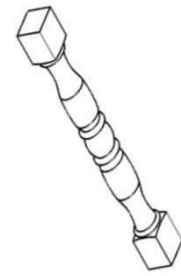
CABINET SPECIFICATION		WEIGHT	DIMENSION		AVAILABILITY														
SKU	LB	W" x H" x D"	DS	ES	SO	SG	SM	AB	CT	PE	NT	AL	TS	WS	CS	SS	GS	US	
FLUTED BEADED FILLER EXTENSION - REVERSIBLE																			
	FFE396	4	5 X 3/4 X 96		●	●	●	●	●	●	●	●	●	●	●	●	●	●	●
WALL FILLER																			
	WF330	2	3 X 30 X 3/4		●	●	●	●	●	●	●	●	●	●	●	●	●	●	●
	WF630	2	6 X 30 X 3/4		●	●	●	●	●	●	●	●	●	●	●	●	●	●	●
	WF336	2	3 X 36 X 3/4		●	●	●	●	●	●	●	●	●	●	●	●	●	●	●
	WF636	3	6 X 36 X 3/4		●	●	●	●	●	●	●	●	●	●	●	●	●	●	●
	WF342	2	3 X 42 X 3/4		●	●	●	●	●	●	●	●	●	●	●	●	●	●	●
	WF642	4	6 X 42 X 3/4		●	●	●	●	●	●	●	●	●	●	●	●	●	●	●
	WF1.596	2	1 1/2 X 96 X 3/4		●	●	●	●	●	●	●	●	●	●	●	●	●	●	●
	WF396	5	3 X 96 X 3/4		●	●	●	●	●	●	●	●	●	●	●	●	●	●	●
	WF696	9	6 X 96 X 3/4		●	●	●	●	●	●	●	●	●	●	●	●	●	●	●
BASE FILLER																			
	BF3	2	3 X 34 1/2 X 3/4		●	●	●	●	●	●	●	●	●	●	●	●	●	●	●
	BF6	3	6 X 34 1/2 X 3/4		●	●	●	●	●	●	●	●	●	●	●	●	●	●	●
TURN POST																			
	TP3-1	5	3 X 3 X 34 1/2								●								



JARVIN CABINETS

DS-DOVE WHITE SHAKER
ES-EBONY SHAKER
SO-SODA
SG-STERLING

SM-SMOKY GRAY
AB-ARIA BLUE
CT-CHARLTON
PE-PERLA

NT-NEWPORT
AL-AVALON
WS-WESTON SHAKER
TS-TOFFEE SHAKER

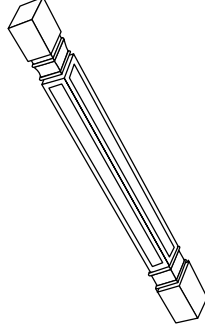
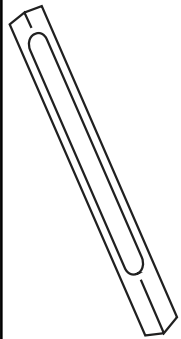
CS-CREAM WHITE SHAKER
SS-SANDY MIRAGE SHAKER
GS-SAGE GREEN SHAKER
US-UNFINISHED BIRCH SHAKER

CABINET SPECIFICATION		WEIGHT	DIMENSION		AVAILABILITY																	
SKU	LB	W" x H" x D"	DS	ES	SO	SG	SM	AB	CT	PE	NT	AL	TS	WS	CS	SS	GS	US				
 TP3-2	5	3 x 3 x 34 1/2	•	•	•	•	•	•														
 PS3	5	3 x 3 x 34 1/2	•	•	•	•	•	•					•							•		
	7	4 x 4 x 34 1/2	•		•	•		•														
 CP3	5	3 x 3 x 34 1/2																			•	
THIS ITEM IS DISCONTINUED. LIMITED STOCK MAY BE AVAILABLE.																						
 CORBF																						
	21	8 1/2 x 34 1/2 x 8																				
	5	8 1/2 x 30 x 4 3/4																				
 CORK30																						









JARVIN CABINETS

DS-DOVE WHITE SHAKER
ES-EBONY SHAKER
SO-SODA
SG-STERLING

SM-SMOKY GRAY
AB-ARIA BLUE
CT-CHARLTON
PE-PERLA

NT-NEWPORT
AL-AVALON
WS-WESTON SHAKER
TS-TOFFEE SHAKER

CS-CREAM WHITE SHAKER
SS-SANDY MIRAGE SHAKER
GS-SAGE GREEN SHAKER
US-UNFINISHED BIRCH SHAKER

CABINET SPECIFICATION		WEIGHT	DIMENSION		AVAILABILITY														
SKU	LB	W" x H" x D"	DS	ES	SO	SG	SM	AB	CT	PE	NT	AL	TS	WS	CS	SS	GS	US	
CORBEL																			
		4 1/2 x 10 x 5							●	●	●	●							
	5	5 x 14 x 7							●	●	●	●							
	8																		
CORBEL																			
		2 3/4 x 8 1/4 x 2 3/4							●	●	●	●							
	2	4 1/2 x 12 1/2 x 4 1/2							●	●	●	●							
	2																		
CORBEL																			
		2 3/4 x 8 1/4 x 2 3/4							●	●	●	●							
	2	4 1/2 x 12 1/2 x 4 1/2																	
	2																		
ONLAY																			
		21 x 4 x 3/8																	
	1																		
ONLAY-B (SOLD BY THE PAIR - LEFT AND RIGHT)																			
		10 1/2 x 3 1/4 x 3/8																	
	1																		



JARVIN CABINETS

DS-DOVE WHITE SHAKER
ES-EBONY SHAKER
SO-SODA
SG-STERLING

SM-SMOKY GRAY
AB-ARIA BLUE
CT-CHARLTON
PE-PERLA

NT-NEWPORT
AL-AVALON
WS-WESTON SHAKER
TS-TOFFEE SHAKER

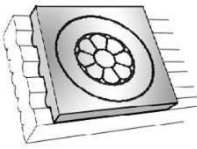
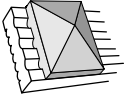
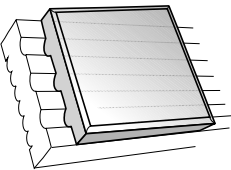
CS-CREAM WHITE SHAKER
SS-SANDY MIRAGE SHAKER
GS-SAGE GREEN SHAKER
US-UNFINISHED BIRCH SHAKER

CABINET SPECIFICATION		WEIGHT	DIMENSION		AVAILABILITY														
SKU	LB	W" x H" x D"	DS	ES	SO	SG	SM	AB	CT	PE	NT	AL	TS	WS	CS	SS	GS	US	
 ROSETTE	FB3	0.5	3 x 3 x 3/8						●	●	●	●							
 PYRAMID BLOCK	PB3	0.5	3 x 3 x 3/8	●	●	●	●	●											
 BLOCK	BLOCK	0.5	3 x 4 x 3/8	●	●	●	●	●	●	●	●	●							
 ARCHED VALANCE	VAL36	3	36 x 5 x 3/4	●	●	●	●	●	●	●	●	●							
	VAL42	3	42 x 5 x 3/4	●	●	●	●	●	●	●	●	●							
	VAL48	4	48 x 5 x 3/4	●	●	●	●	●	●	●	●	●							
	VAL60	5	60 x 5 x 3/4	●	●	●	●	●	●	●	●	●							

JARVIN CABINETS

DS-DOVE WHITE SHAKER

SM-SMOKY GRAY

NT-NEWPORT

CS-CREAM WHITE SHAKER

ES-EBONY SHAKER

AB-ARIA BLUE

AL-AVALON

SS-SANDY MIRAGE SHAKER

SO-SODA

CT-CHARLTON

WS-WESTON SHAKER



GS-SAGE GREEN SHAKER

SG-STERLING

PE-PERLA

TS-TOFFEE SHAKER

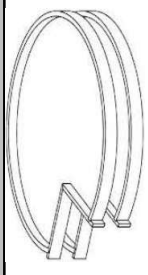
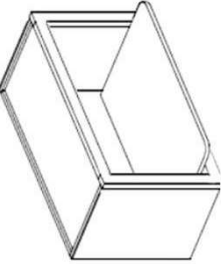
US-UNFINISHED BIRCH SHAKER

CABINET SPECIFICATION		WEIGHT		DIMENSION		AVAILABILITY														
		SKU	LB	W" x H" x D"	DS	ES	SO	SG	SM	AB	CT	PE	NT	AL	TS	WS	CS	SS	GS	US
	UD15	12	11 1/4 x 21 x 4	•	•	•	•	•	•	•	•	•	•	•	•	•	•	•	•	•
	UD18	14	14 1/4 x 21 x 4	•	•	•	•	•	•	•	•	•	•	•	•	•	•	•	•	•
	UD21	16	17 1/4 x 21 x 4	•	•	•	•	•	•	•	•	•	•	•	•	•	•	•	•	•
	UD24	18	21 1/4 x 21 x 4	•	•	•	•	•	•	•	•	•	•	•	•	•	•	•	•	•
	BLSTRAY	20	27 5/16	•	•	•	•	•	•	•	•	•	•	•	•	•	•	•	•	•
	WMC3018	25	30 x 18 x 17 3/4	•	•	•	•	•	•	•	•	•	•	•	•	•	•	•	•	•
	RRP96	32	3 x 96 x 27	•	•	•	•	•	•	•	•	•	•	•	•	•	•	•	•	•
	DWP	10	3 x 34 1/2 x 24	•	•	•	•	•	•	•	•	•	•	•	•	•	•	•	•	•

JARVIN CABINETS

DS-DOVE WHITE SHAKER
 ES-EBONY SHAKER
 SO-SODA
 SG-STERLING

SM-SMOKY GRAY
 AB-ARIA BLUE
 CT-CHARLTON
 PE-PERLA

NT-NEWPORT
 AL-AVALON
 WS-WESTON SHAKER
 TS-TOFFEE SHAKER

CS-CREAM WHITE SHAKER
 SS-SANDY MIRAGE SHAKER
 GS-SAGE GREEN SHAKER
 US-UNFINISHED BIRCH SHAKER

CABINET SPECIFICATION		WEIGHT	DIMENSION										AVAILABILITY									
SKU	LB	W" x H" x D"	DS	ES	SO	SG	SM	AB	CT	PE	NT	AL	TS	WS	CS	SS	GS	US				
SKIN PANEL (2 SIDES FINISHED) AND 3/4" PANEL (2 SIDES AND 4 EDGES FINISHED)																						
BP3696	16	36 x 96 x 1/4	●	●	●	●	●	●	●	●	●	●	●	●	●	●	●	●	●			
BP4896	37	48 x 96 x 1/4	●	●	●	●	●	●	●	●	●	●	●	●	●	●	●	●	●			
FP2496	37	24 x 96 x 3/4	●	●	●	●	●	●	●	●	●	●	●	●	●	●	●	●	●			
FP3696	50	36 x 96 x 3/4	●	●	●	●	●	●	●	●	●	●	●	●	●	●	●	●	●			
FP4896	73	48 x 96 x 3/4	●	●	●	●	●	●	●	●	●	●	●	●	●	●	●	●	●			
SOFT CLOSING UNDER MOUNT GLIDES																						
GLIDE12	1	For 12" Deep Cabinet	●	●	●	●	●	●	●	●	●	●	●	●	●	●	●	●	●			
GLIDE15	1	For 15" Deep Cabinet	●	●	●	●	●	●	●	●	●	●	●	●	●	●	●	●	●			
GLIDE18	1.5	For 18" Deep Cabinet	●	●	●	●	●	●	●	●	●	●	●	●	●	●	●	●	●			
GLIDE21	2	For 21" Deep Cabinet	●	●	●	●	●	●	●	●	●	●	●	●	●	●	●	●	●			
GLIDE24	2.5	For 24" Deep Cabinet	●	●	●	●	●	●	●	●	●	●	●	●	●	●	●	●	●			

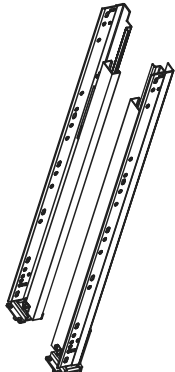
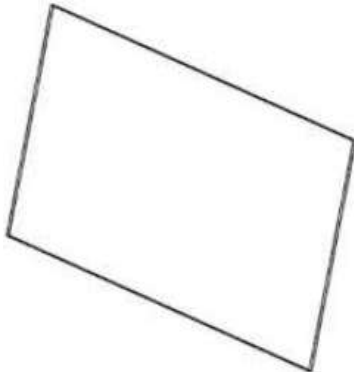

JARWIN CABINETS

DS-DOVE WHITE SHAKER

ES-EBONY SHAKER

SO-SODA

SG-STERLING

SM-SMOKY GRAY

AB-ARIA BLUE

CT-CHARLTON

PE-PERLA

NT-NEWPORT

AL-AVALON

WS-WESTON SHAKER

TS-TOFFEE SHAKER

CS-CREAM WHITE SHAKER

SS-SANDY MIRAGE SHAKER

GS-SAGE GREEN SHAKER

US-UNFINISHED BIRCH SHAKER

CABINET SPECIFICATION		WEIGHT	DIMENSION		AVAILABILITY														
SKU	LB	W" x H" x D"	DS	ES	SO	SG	SM	AB	CT	PE	NT	AL	TS	WS	CS	SS	GS	US	
MULLION GLASS DOORS-TEXTURED GLASS*																			
WM1230	5	12 x 30 x 3/4																	
WM1530	7	15 x 30 x 3/4																	
WM1830	8	18 x 30 x 3/4																	
WM2130	10	21 x 30 x 3/4																	
WM1236	7	12 x 36 x 3/4																	
WM1536	8	15 x 36 x 3/4																	
WM1836	10	18 x 36 x 3/4																	
WM2136	12	21 x 36 x 3/4																	
WM1242	7	12 x 42 x 3/4																	
WM1542	9	15 x 42 x 3/4																	
WM1842	10	18 x 42 x 3/4																	
WM2142	12	21 x 42 x 3/4																	
WM2430	11	24 x 30 x 3/4																	
WM2730	14	27 x 30 x 3/4																	
WM3030	15	30 x 30 x 3/4																	
WM3330	18	33 x 30 x 3/4																	
WM3630	19	36 x 30 x 3/4																	
WM2436	16	26 x 36 x 3/4																	
WM2736	17	27 x 36 x 3/4																	
WM3036	18	30 x 36 x 3/4																	
WM3336	19	33 x 36 x 3/4																	
WM3636	20	36 x 36 x 3/4																	
WM2442	15	24 x 42 x 3/4																	
WM2742	21	27 x 42 x 3/4																	
WM3042	22	30 x 42 x 3/4																	
WM3342	24	33 x 42 x 3/4																	
WM3642	26	34 x 42 x 3/4																	
WM15 CAN BE USED ON WDC CABINETS, DOUBLE DOORS SIZES ARE IDENTICAL WITH SINGLE DOORS																			

MULLION GLASS DOORS
ONLY FOR CT, PE, NT & AL

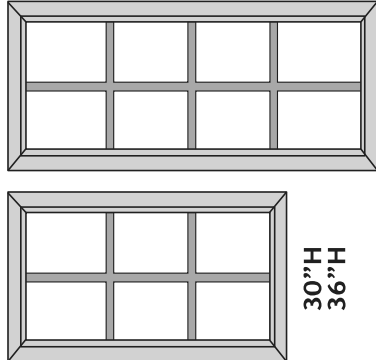

30"H
36"H

42"H

24" WIDE CABINETS
USE 2 x WM12 DOORS

30" WIDE CABINETS
USE 2 x WM15 DOORS

36" WIDE CABINETS
USE 2 x WM18 DOORS

JARWIN CABINETS

DS-DOVE WHITE SHAKER

SM-SMOKY GRAY

NT-NEWPORT

CS-CREAM WHITE SHAKER

ES-EBONY SHAKER

AB-ARIA BLUE

AL-AVALON

SS-SANDY MIRAGE SHAKER

SO-SODA

CT-CHARLTON

WS-WESTON SHAKER

GS-SAGE GREEN SHAKER

SG-STERLING

PE-PERLA

TS-TOFFEE SHAKER

US-UNFINISHED BIRCH SHAKER

CABINET SPECIFICATION		WEIGHT	DIMENSION		AVAILABILITY														
SKU	LB	W" x H" x D"	DS	ES	SO	SG	SM	AB	CT	PE	NT	AL	TS	WS	CS	SS	GS	US	
SIZES BELOW SOLD IN PAIRS																			
WM2412	8	24 x 12 x ¾"	●																
WM2712	7	27 x 12 x ¾"	●																
WM3012	10	30 x 12 x ¾"	●																
WM3312	12	33 x 12 x ¾"	●																
WM3612	13	36 x 12 x ¾"	●																
WM2418	8	24 x 18 x ¾"	●	●															
WM2718	9	27 x 18 x ¾"	●	●															
WM3018	10	30 x 18 x ¾"	●	●															
WM3318	14	33 x 18 x ¾"	●	●															
WM3618	15	36 x 18 x ¾"	●	●															
WM2430	18	24 x 30 x ¾"	●	●	●		●						●	●	●				
WM2730	19	27 x 30 x ¾"	●	●	●		●												
WM3030	20	30 x 30 x ¾"	●	●	●		●						●	●	●				
WM3330	21	33 x 30 x ¾"	●	●	●		●												
WM3630	22	36 x 30 x ¾"	●	●	●		●						●	●	●				
WM2436	22	24 x 36 x ¾"	●	●	●		●						●	●	●				
WM2736	23	27 x 36 x ¾"	●	●	●		●												
WM3036	24	30 x 36 x ¾"	●	●	●		●						●	●	●				
WM3336	25	33 x 36 x ¾"	●	●	●		●												
WM3636	26	36 x 36 x ¾"	●	●	●		●						●	●	●				
WM2442	24	24 x 42 x ¾"	●	●	●		●						●	●	●				
WM2742	25	27 x 42 x ¾"	●	●	●		●												
WM3042	26	30 x 42 x ¾"	●	●	●		●						●	●	●				
WM3342	27	33 x 42 x ¾"	●	●	●		●												
WM3642	28	36 x 42 x ¾"	●	●	●		●						●	●	●				
WM15 CAN BE USED ON WDC CABINETS, DOUBLE DOORS SIZES ARE IDENTICAL WITH SINGLE DOORS																			

GLASS DOORS-TEXTURED GLASS*

OPEN FRAME GLASS DOORS ONLY FOR DS, ES, SO & SG

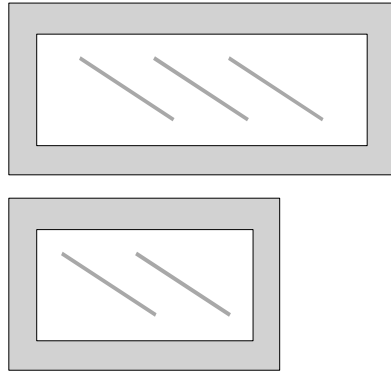

24" WIDE CABINETS
USE 2 x WM12 DOORS

30" WIDE CABINETS
USE 2 x WM15 DOORS

36" WIDE CABINETS
USE 2 x WM18 DOORS